

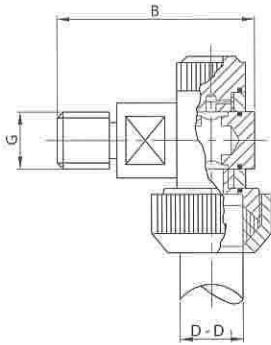

PORTALIVELLO SUP. GAS
 UPPER LEVEL GAUGE BSP
 M. SUP. DE NIVEAU GAS
 GRIFO NIVEL SUP. GAS

047 G



DN	B	D	D ₁	G	gr
12	66,5	22,0	16,0	1/2"	275

PORTALIVELLO SUP. FL.
 UPPER LEVEL GAUGE FL.
 M. SUP. DE NIVEAU BR.
 GRIFO NIVEL SUP. BRIDA

047 F/O

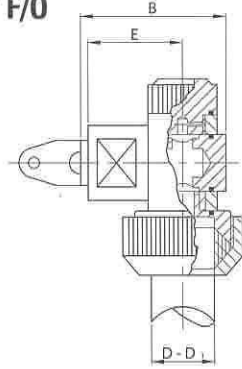

DN	B	D	D ₁	E	gr
1/2"	51,5	22,0	16,0	30,0	340

PORTALIVELLO SUP. NPT
 UPPER LEVEL GAUGE NPT
 M. SUP. DE NIVEAU NPT
 GRIFO NIVEL SUP. NPT

T47

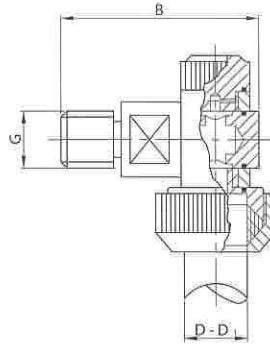

DN	B	D	D ₁	G	gr	
1 1/2"	38	66,5	16,0	22,0	3/8"	275

PORTALIVELLO SUP. E. SM.
 UPPER LEVEL GAUGE E. FR.
 M. SUP. DE NIVEAU B. FR.
 GRIFO NIVEL SUP. E. SM.

K47

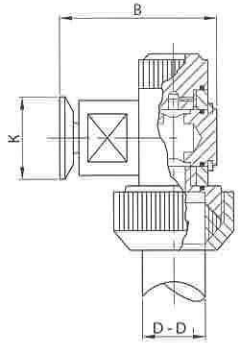

DN	B	D	D ₁	K	gr	
1"	25	56,5	16,0	22,0	50,5	300

RUB. PORTALIVELLO GAS
 LOWER LEVEL GAUGE BSP
 ROBINET DE NIVEAU GAS
 GRIFO NIVEL GAS

038 G

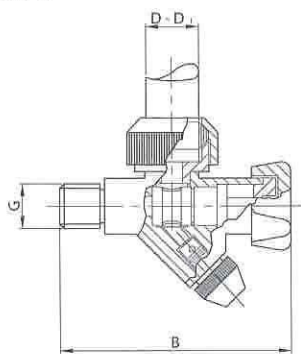

DN	B	D	D ₁	G	gr
12	105,0	22,0	16,0	1/2"	515

RUB. PORTALIVELLO FL.
 LOWER LEVEL GAUGE FL.
 ROBINET DE NIVEAU BR.
 GRIFO NIVEL BRIDA

038 F/O

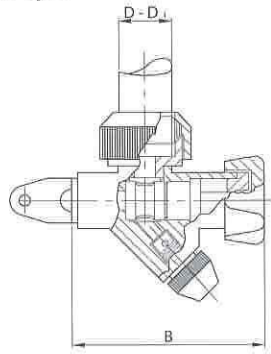

DN	B	D	D ₁	gr
1/2"	91,0	22,0	16,0	520

RUB. PORTALIVELLO NPT
 LOWER LEVEL GAUGE NPT
 ROB. DE NIVEAU NPT
 GRIFO NIVEL NPT

T38

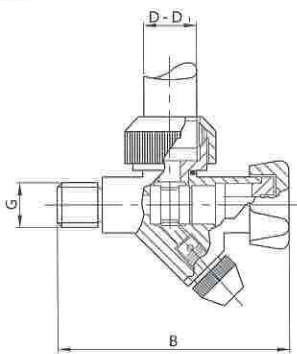

DN	B	D	D ₁	G	gr	
1 1/2"	38	110,0	16,0	22,0	3/8"	515

RUB. PORTALIVELLO E. SM.
 LOWER LEVEL GAUGE E. FR.
 ROB. DE NIVEAU B. FR.
 GRIFO NIVEL E. SM.

K38

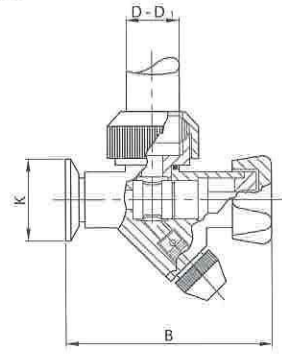

DN	B	D	D ₁	K	gr	
1"	25	99,0	16,0	22,0	50,5	530